

DATA SHEET

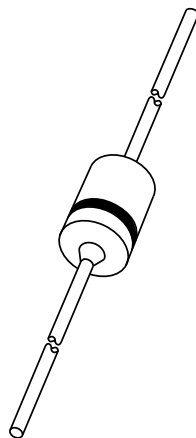

BZX55 series Voltage regulator diodes

Product specification
Supersedes data of April 1992
File under Discrete Semiconductors, SC01

1996 Apr 26

Voltage regulator diodes

BZX55 series

FEATURES

- Total power dissipation: max. 500 mW
- Tolerance series: $\pm 5\%$
- Working voltage range: nom. 2.4 to 75 V (E24 range)
- Non-repetitive peak reverse power dissipation: max. 40 W.

APPLICATIONS

- Low voltage stabilizers or voltage references.

DESCRIPTION

Low-power voltage regulator diodes in hermetically sealed leaded glass SOD27 (DO-35) packages.

The diodes are available in the normalized E24 $\pm 5\%$ tolerance range. The series consists of 37 types with nominal working voltages from 2.4 to 75 V (BZX55-C2V4 to BZX55-C75).

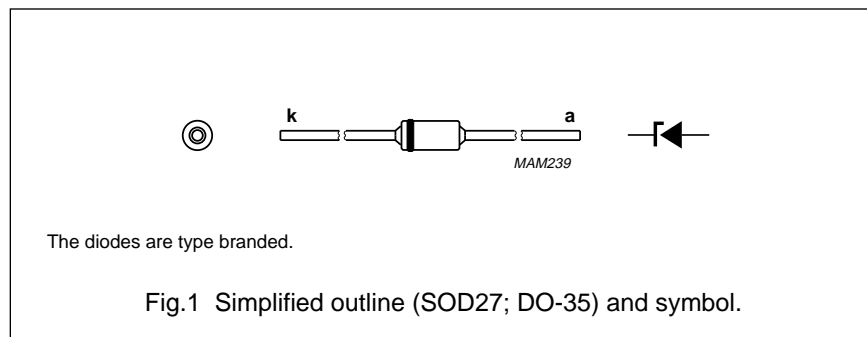

LIMITING VALUES

In accordance with the Absolute Maximum Rating System (IEC 134).

SYMBOL	PARAMETER	CONDITIONS	MIN.	MAX.	UNIT
I_F	continuous forward current		–	250	mA
I_{ZSM}	non-repetitive peak reverse current	$t_p = 100 \mu\text{s}$; square wave; $T_j = 25 \text{ }^\circ\text{C}$ prior to surge	see Table "Per type"		
P_{tot}	total power dissipation	$T_{amb} = 50 \text{ }^\circ\text{C}$; note 1	–	400	mW
		$T_{amb} = 50 \text{ }^\circ\text{C}$; note 2	–	500	mW
P_{ZSM}	non-repetitive peak reverse power dissipation	$t_p = 100 \mu\text{s}$; square wave; $T_j = 25 \text{ }^\circ\text{C}$ prior to surge	–	40	W
		$t_p = 8.3 \text{ ms}$; square wave; $T_j \leq 150 \text{ }^\circ\text{C}$ prior to surge	–	30	W
T_{stg}	storage temperature		–65	+200	$^\circ\text{C}$
T_j	junction temperature		–	200	$^\circ\text{C}$

Notes

1. Device mounted on a printed circuit-board without metallization pad; lead length max.
2. Tie-point temperature $\leq 50 \text{ }^\circ\text{C}$; lead length 8 mm.

ELECTRICAL CHARACTERISTICS

Total series

$T_j = 25 \text{ }^\circ\text{C}$; unless otherwise specified.

SYMBOL	PARAMETER	CONDITIONS	MIN.	MAX.	UNIT
V_F	forward voltage	$I_F = 100 \text{ mA}$; see Fig.4	–	1.0	V

Voltage regulator diodes

BZX55 series

Per type

 $T_j = 25\text{ }^\circ\text{C}$; unless otherwise specified.

BZX55- CXXX	WORKING VOLTAGE V_Z (V) at I_{Ztest}		DIFFERENTIAL RESISTANCE r_{dif} (Ω)		TEMP. COEFF. S_Z (mV/K) at I_{Ztest} see Figs 5 and 6	TEST CURRENT I_{Ztest} (mA)	DIODE CAP. C_d (pF) at $f = 1\text{ MHz}$; at $V_R = 0\text{ V}$	REVERSE CURRENT at REVERSE VOLTAGE			NON-REPETITIVE PEAK REVERSE CURRENT I_{ZSM} (A) at $t_p = 100\text{ }\mu\text{s}$; $T_{amb} = 25\text{ }^\circ\text{C}$
	MIN.	MAX.	at I_Z	at I_{Ztest}				at $T_j = 25\text{ }^\circ\text{C}$	at $T_j = 150\text{ }^\circ\text{C}$	V_R (V)	
		MAX.		MAX.	TYP.		MAX.	MAX.	MAX.	MAX.	
2V4	2.28	2.56	600	85	-1.8	5	450	50	100	1.0	6.0
2V7	2.5	2.9	600	85	-1.9	5	450	10	50	1.0	6.0
3V0	2.8	3.2	600	85	-2.1	5	450	4	40	1.0	6.0
3V3	3.1	3.5	600	85	-2.2	5	450	2	40	1.0	6.0
3V6	3.4	3.8	600	85	-2.4	5	450	2	40	1.0	6.0
3V9	3.7	4.1	600	85	-2.4	5	450	2	40	1.0	6.0
4V3	4.0	4.6	600	80	-2.4	5	450	1	20	1.0	6.0
4V7	4.4	5.0	600	70	-1.4	5	300	0.5	10	1.0	6.0
5V1	4.8	5.4	550	50	-0.8	5	300	0.1	2	1.0	6.0
5V6	5.2	6.0	450	30	1.6	5	300	0.1	2	1.0	6.0
6V2	5.8	6.6	200	10	2.2	5	200	0.1	2	2.0	6.0
6V8	6.4	7.2	150	8	3.0	5	200	0.1	2	3.0	6.0
7V5	7.0	7.9	50	7	3.8	5	150	0.1	2	5.0	4.0
8V2	7.7	8.7	50	7	4.5	5	150	0.1	2	6.15	4.0
9V1	8.5	9.6	50	10	5.5	5	150	0.1	2	6.8	3.0
10	9.4	10.6	70	15	6.5	5	90	0.1	2	7.5	3.0
11	10.4	11.6	70	20	7.7	5	85	0.1	2	8.25	2.5
12	11.4	12.7	90	20	8.4	5	85	0.1	2	9.0	2.5
13	12.4	14.1	110	26	9.8	5	80	0.1	2	9.75	2.5
15	13.8	15.6	110	30	11.3	5	75	0.1	2	11.25	2.0
16	15.3	17.1	170	40	12.8	5	75	0.1	2	12.0	1.5
18	16.8	19.1	170	50	14.4	5	70	0.1	2	13.5	1.5
20	18.8	21.2	220	55	16.0	5	60	0.1	2	15.0	1.5

Voltage regulator diodes

BZX55 series

BZX55- CXXX	WORKING VOLTAGE V_Z (V) at I_{Ztest}		DIFFERENTIAL RESISTANCE r_{dif} (Ω)		TEMP. COEFF. S_Z (mV/K) at I_{Ztest} see Figs 5 and 6	TEST CURRENT I_{Ztest} (mA)	DIODE CAP. C_d (pF) at $f = 1$ MHz; at $V_R = 0$ V	REVERSE CURRENT at REVERSE VOLTAGE			NON-REPETITIVE PEAK REVERSE CURRENT I_{ZSM} (A) at $t_p = 100 \mu s$; $T_{amb} = 25^\circ C$	
	MIN.	MAX.	at I_Z	at I_{Ztest}				MAX.	at $T_j = 25^\circ C$	I_R (μA)		MAX.
					at $T_j = 150^\circ C$	V_R (V)	MAX.					
22	20.8	23.3	220	55	18.7	5	MAX.	MAX.	0.1	2	16.5	1.25
24	22.8	25.6	220	80	20.4	5	MAX.	MAX.	0.1	2	18.0	1.25
27	25.1	28.9	220	80	22.9	5	MAX.	MAX.	0.1	2	20.25	1.0
30	28.0	32.0	220	80	27.0	5	MAX.	MAX.	0.1	2	22.25	1.0
33	31.0	35.0	220	80	29.7	5	MAX.	MAX.	0.1	2	24.75	0.9
36	34.0	38.0	220	80	32.4	5	MAX.	MAX.	0.1	2	27.0	0.8
39	37.0	41.0	500	90	35.1	2.5	MAX.	MAX.	0.1	2	29.25	0.7
43	40.0	46.0	600	90	38.7	2.5	MAX.	MAX.	0.1	2	32.25	0.6
47	44.0	50.0	700	110	44.0	2.5	MAX.	MAX.	0.1	2	35.25	0.5
51	48.0	54.0	700	125	49.0	2.5	MAX.	MAX.	0.1	2	38.25	0.4
56	52.0	60.0	1000	135	55.0	2.5	MAX.	MAX.	0.1	2	42.0	0.3
62	58.0	66.0	1000	150	62.0	2.5	MAX.	MAX.	0.1	2	46.5	0.3
68	64.0	72.0	1000	200	70.0	2.5	MAX.	MAX.	0.1	2	51.0	0.25
75	70.0	79.0	1500	250	78.0	2.5	MAX.	MAX.	0.1	2	56.25	0.2

Note

- For BZX55-C2V4 up to C36 $I_Z = 1$ mA; for C39 up to C75 $I_Z = 0.5$ mA.

Voltage regulator diodes

BZX55 series

THERMAL CHARACTERISTICS

SYMBOL	PARAMETER	CONDITIONS	VALUE	UNIT
$R_{th\ j-tp}$	thermal resistance from junction to tie-point	lead length 8 mm	300	K/W
$R_{th\ j-a}$	thermal resistance from junction to ambient	lead length max.; see Fig.2 and note 1	380	K/W

Note

1. Device mounted on a printed circuit-board without metallization pad.

Voltage regulator diodes

BZX55 series

GRAPHICAL DATA

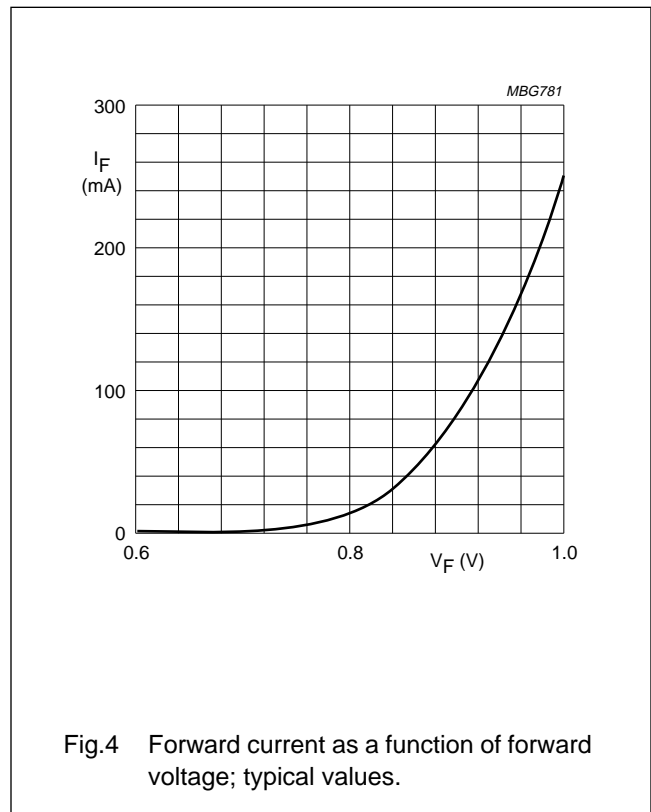
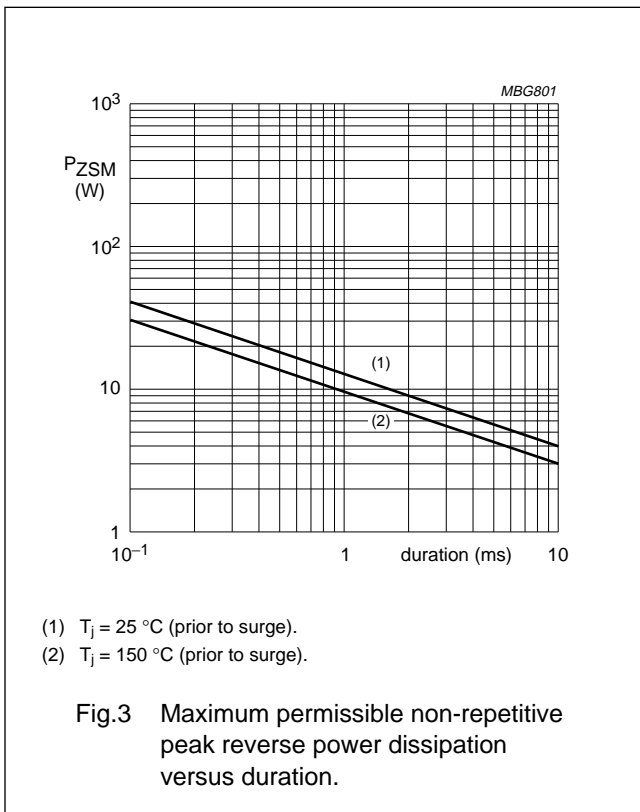
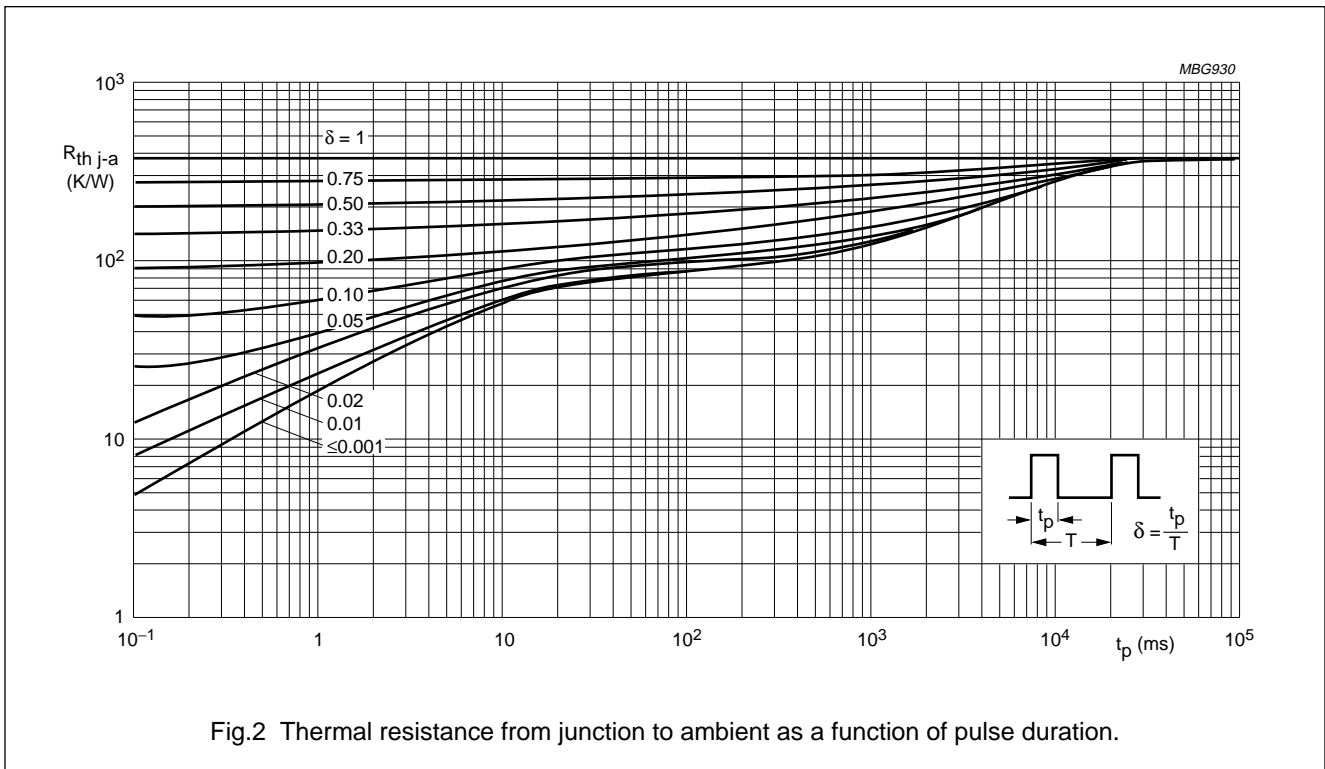

Voltage regulator diodes

BZX55 series

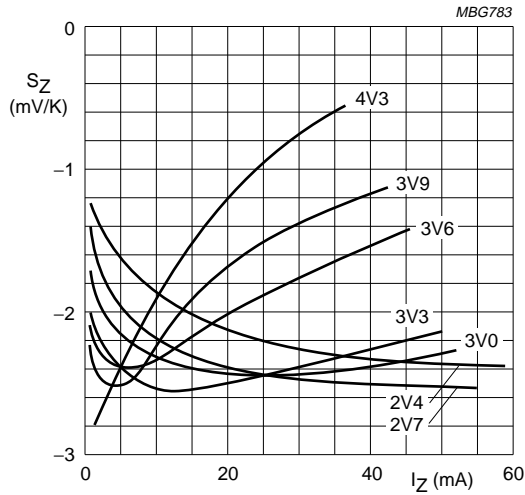

BZX55-C2V4 to C4V3.
 $T_j = 25$ to 150 °C.

Fig.5 Temperature coefficient as a function of working current; typical values.

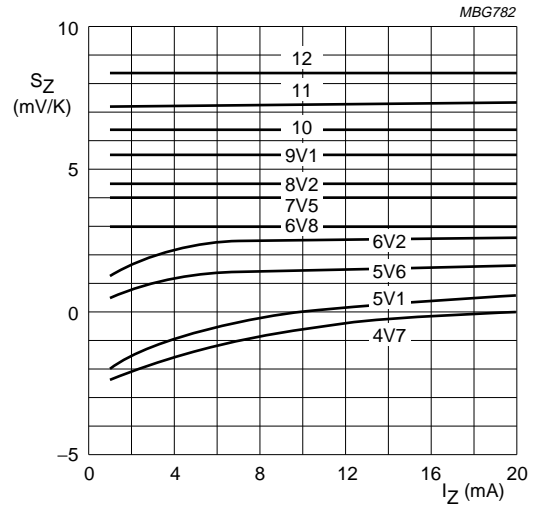

BZX55-C4V7 to C12.
 $T_j = 25$ to 150 °C.

Fig.6 Temperature coefficient as a function of working current; typical values.

Voltage regulator diodes

BZX55 series

PACKAGE OUTLINE

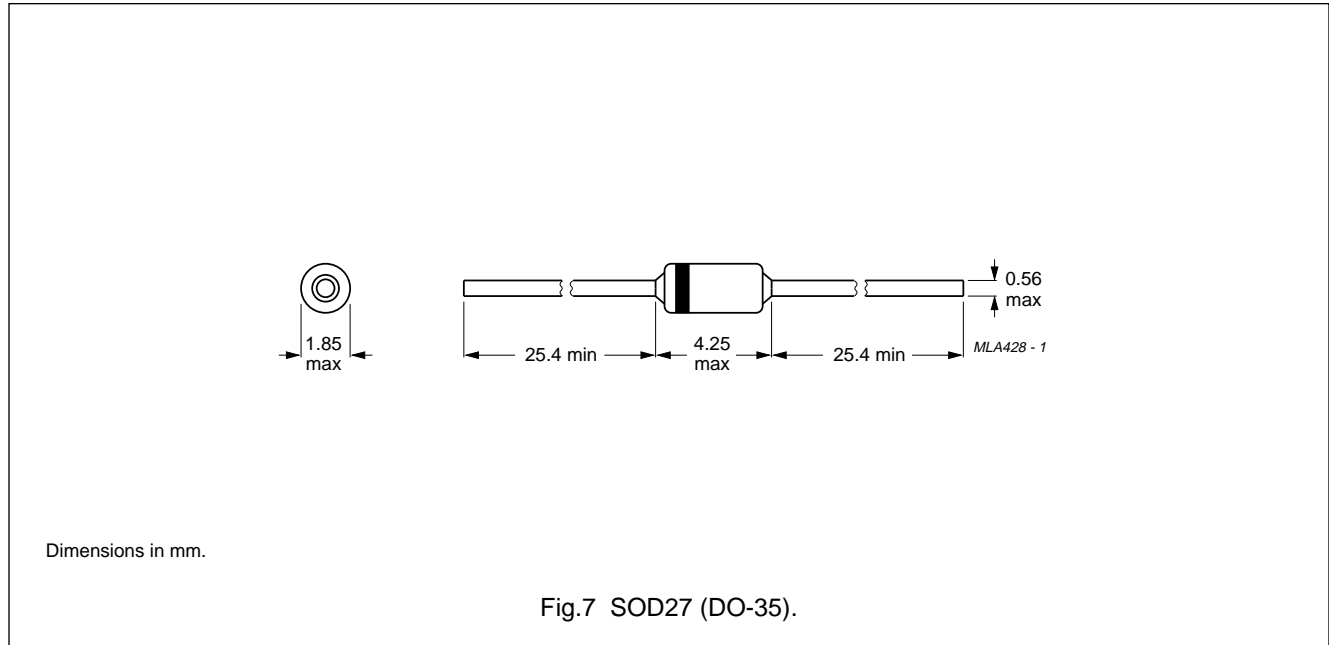

DEFINITIONS

Data sheet status	
Objective specification	This data sheet contains target or goal specifications for product development.
Preliminary specification	This data sheet contains preliminary data; supplementary data may be published later.
Product specification	This data sheet contains final product specifications.
Limiting values	
Limiting values given are in accordance with the Absolute Maximum Rating System (IEC 134). Stress above one or more of the limiting values may cause permanent damage to the device. These are stress ratings only and operation of the device at these or at any other conditions above those given in the Characteristics sections of the specification is not implied. Exposure to limiting values for extended periods may affect device reliability.	
Application information	
Where application information is given, it is advisory and does not form part of the specification.	

LIFE SUPPORT APPLICATIONS

These products are not designed for use in life support appliances, devices, or systems where malfunction of these products can reasonably be expected to result in personal injury. Philips customers using or selling these products for use in such applications do so at their own risk and agree to fully indemnify Philips for any damages resulting from such improper use or sale.