

MAC97A6/8

TRIACS

LOGIC LEVEL TRIAC

DESCRIPTION

Logic level sensitive gate triac intended to be interfaced directly to microcontrollers, logic integrated circuits and other low power gate trigger circuits.

FEATURES

- *Blocking voltage to 600 V (MAC97A8)
- *RMS on-state current to 0.6 A
- *Sensitive gate in all four quadrants

APPLICATIONS

- *General purpose bidirectional switching
- *Phase control applications
- *Solid state relays.

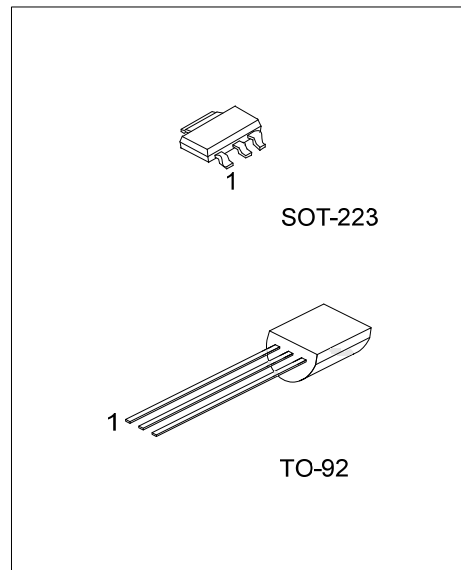
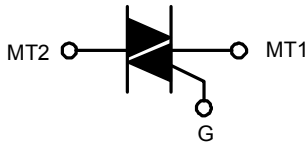
SYMBOL

ORDERING INFORMATION

Order Number		Package	Pin Assignment			Packing
Lead Free	Halogen Free		1	2	3	
MAC97A6L-AA3-R	MAC97A6G-AA3-R	SOT-223	MT1	MT2	Gate	Tape Reel
MAC97A6L-T92-B	MAC97A6G-T92-B	TO-92	MT1	Gate	MT2	Tape Box
MAC97A6L-T92-K	MAC97A6G-T92-K	TO-92	MT1	Gate	MT2	Bulk
MAC97A6L-T92-R	MAC97A6G-T92-R	TO-92	MT1	Gate	MT2	Tape Reel
MAC97A8L-AA3-R	MAC97A8G-AA3-R	SOT-223	MT1	MT2	Gate	Tape Reel
MAC97A8L-T92-B	MAC97A8G-T92-B	TO-92	MT1	Gate	MT2	Tape Box
MAC97A8L-T92-K	MAC97A8G-T92-K	TO-92	MT1	Gate	MT2	Bulk
MAC97A8L-T92-R	MAC97A8G-T92-R	TO-92	MT1	Gate	MT2	Tape Reel

<p>MAC97A6L-AA3-R</p> <p>(1)Packing Type</p> <p>(2)Package Type</p> <p>(3)Lead Free</p>	<p>(1) B: Tape Box, K: Bulk, R: Tape Reel</p> <p>(2) AA3: SOT-223, T92: TO-92</p> <p>(3) G: Halogen Free, L: Lead Free</p>
---	--

■ ABSOLUTE MAXIMUM RATINGS

CHARACTERISTIC		SYMBOL	RATINGS	UNIT
Repetitive Peak off-State Voltage ($T_J=25 \sim 125^\circ\text{C}$)	MAC97A6	V_{DRM}	400	V
	MAC97A8		600	V
RMS on-State Current (Full Sine Wave, $T_{\text{LEAD}} \leq 50^\circ\text{C}$)		$I_{\text{T(RMS)}}$	0.6	A
Non-Repetitive Peak on-State Current (Full Sine Wave, $T_J=25^\circ\text{C}$ Prior to Surge)	$t=20\text{ms}$	I_{TSM}	8.0	A
	$t=16.7\text{ms}$		8.8	A
I^2t for Fusing ($t=10\text{ms}$)		I^2t	0.32	A^2s
Repetitive Rate of Rise of on-State Current After Triggering ($I_{\text{TM}}=1.0\text{A}$, $I_G=0.2\text{A}$, $dI_G/dt=0.2\text{A}/\mu\text{s}$)	T2+G+	dI_T/dt	50	$\text{A}/\mu\text{s}$
	T2+G-		50	$\text{A}/\mu\text{s}$
	T2-G-		50	$\text{A}/\mu\text{s}$
	T2-G+		10	$\text{A}/\mu\text{s}$
Peak Gate Voltage [$t=2\mu\text{s}$ (max)]		V_{GM}	5	V
Peak Gate Current [$t=2\mu\text{s}$ (max)]		I_{GM}	1	A
Peak Gate Power [$t=2\mu\text{s}$ (max)]		P_{GM}	5	W
Average Gate Power [$T_C=80^\circ\text{C}$, $t=2\mu\text{s}$ (max)]		$P_{\text{G(AV)}}$	0.1	W
Operating Junction Temperature		T_J	$-40 \sim +125$	$^\circ\text{C}$
Storage Temperature		T_{STG}	$-40 \sim +150$	$^\circ\text{C}$

Note: Absolute maximum ratings are those values beyond which the device could be permanently damaged.

Absolute maximum ratings are stress ratings only and functional device operation is not implied.

■ THERMAL DATA

PARAMETER		SYMBOL	RATINGS	UNIT
Junction to Ambient	TO-92	θ_{JA}	150	$^\circ\text{C}/\text{W}$
	SOT-223		165	$^\circ\text{C}/\text{W}$

■ STATIC CHARACTERISTICS ($T_J=25^\circ\text{C}$, unless otherwise specified)

PARAMETER	SYMBOL	TEST CONDITIONS	MIN	TYP	MAX	UNITS
Gate Trigger Current	I_{GT}	$V_D=12\text{V}$, $I_T=0.1\text{A}$	T2+G+	1	5	mA
			T2+G-	2	5	mA
			T2-G-	2	5	mA
			T2-G+	4	7	mA
Latching Current	I_L	$V_D=12\text{V}$, $I_{\text{GT}}=0.1\text{A}$	T2+G+	1	10	mA
			T2+G-	5	10	mA
			T2-G-	1	10	mA
			T2-G+	2	10	mA
Holding Current	I_H	$V_D=12\text{V}$, $I_{\text{GT}}=0.1\text{A}$		1	10	mA
On-State Voltage	V_T	$I_T=0.85\text{A}$		1.4	1.9	V
Gate Trigger Voltage	V_{GT}	$V_D=12\text{V}$, $I_T=0.1\text{A}$		0.9	2	V
		$V_D=V_{\text{DRM}}$, $I_T=0.1\text{A}$, $T_J=110^\circ\text{C}$	0.1	0.7		V
Off-State Leakage Current	I_D	$V_D=V_{\text{DRM(MAX)}}$, $T_J=110^\circ\text{C}$		3	100	μA

■ DYNAMIC CHARACTERISTICS ($T_J=25^\circ\text{C}$, unless otherwise specified)

PARAMETER	SYMBOL	CONDITIONS	MIN	TYP	MAX	UNITS
Critical Rate of Rise of Off-State Voltage	dV_D/dt	$V_D=67\%$ of $V_{\text{DRM(MAX)}}$, $T_C=110^\circ\text{C}$, Exponential Waveform, Gate Open Circuit	30	45		$\text{V}/\mu\text{s}$
Critical Rate of Rise of Commutation Voltage	dV_{COM}/dt	$V_D=\text{Rated } V_{\text{DRM}}$, $T_C=50^\circ\text{C}$, $I_{\text{TM}}=0.84\text{A}$, commutating $dI/dt=0.3\text{A}/\text{ms}$		5		$\text{V}/\mu\text{s}$
Gate Controlled Turn-On Time	t_{GT}	$I_{\text{TM}}=1.0\text{A}$, $V_D=V_{\text{DRM(MAX)}}$, $I_G=25\text{mA}$, $dI_G/dt=5\text{A}/\mu\text{s}$		2		μs

TYPICAL CHARACTERISTICS

Transient Thermal Impedance From Junction to Ambient as a Function of Pulse Duration.

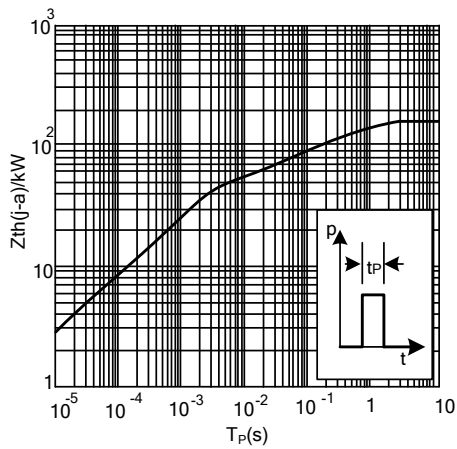

Maximum Permissible Non-Repetitive Peak on-State Current as a Function of Pulse Width for Sinusoidal Currents; Typical Values. $t_p \leq 20\text{ms}$.

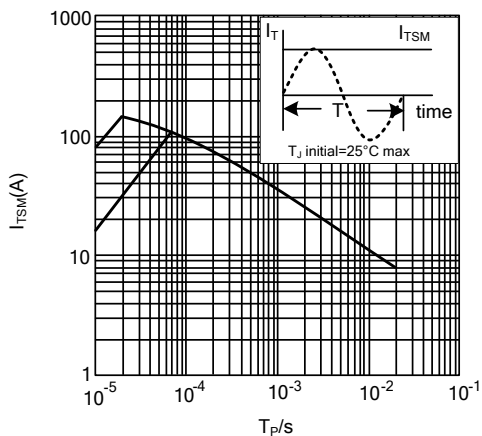

Maximum Permissible RMS Current as a Function of Lead Temperature; Typical Values.

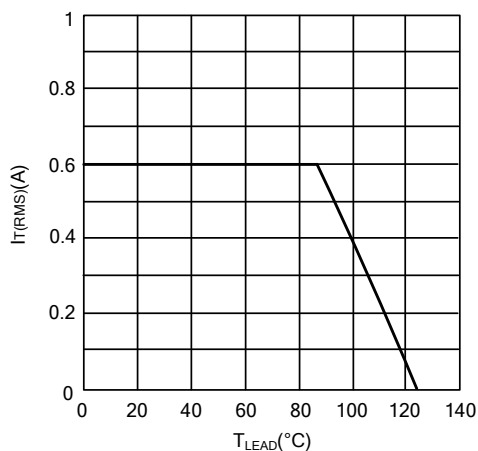

Maximum On-State Dissipation as a Function of RMS On-State Current; Typical Values. $\alpha = \text{Conduction Angle}$.

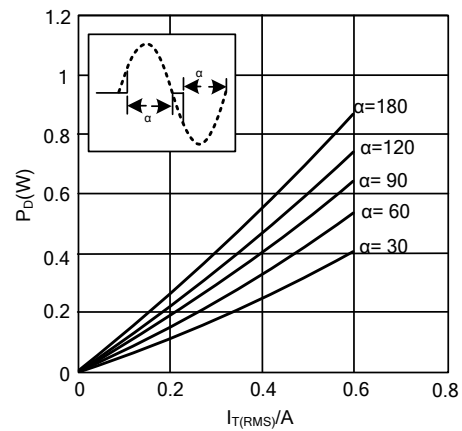

Maximum Permissible Non-Repetitive Peak On-State Current as a Function of Number of Cycles for Sinusoidal Currents; Typical Values. $n = \text{Number of Cycles at } f = 50\text{Hz}$.

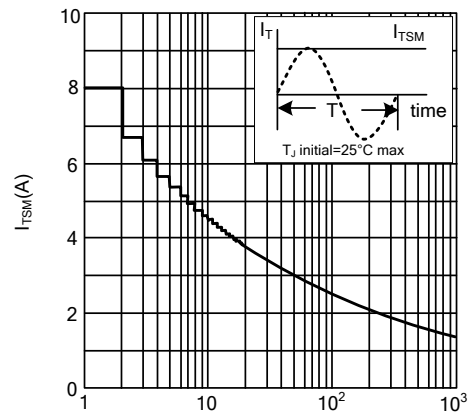

Maximum Permissible Repetitive RMS On-State Current as a Function of Surge Duration for Sinusoidal Currents; Typical Values. $f = 50\text{Hz}$; $T_{\text{LEAD}} \leq 50^\circ\text{C}$.

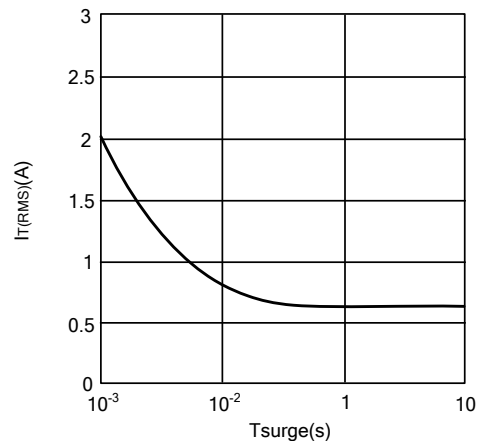

■ TYPICAL CHARACTERISTICS(Cont.)

Normalized Gate Trigger Voltage as a Function of Junction Temperature; Typical Values.

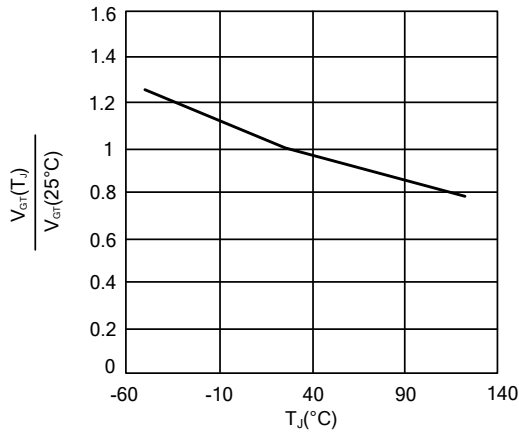

Normalized Gate Trigger Current as a Function of Junction Temperature; Typical Values.

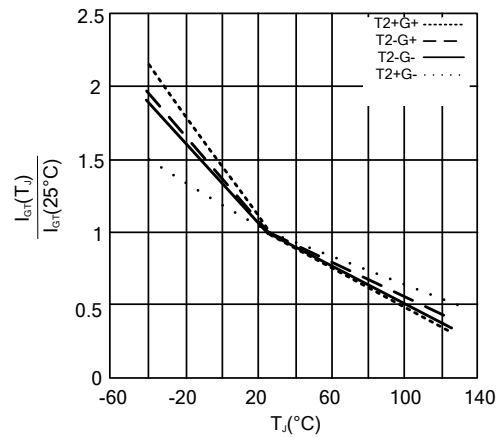

Normalized Latching Current as a Function of Junction Temperature; Typical Values.

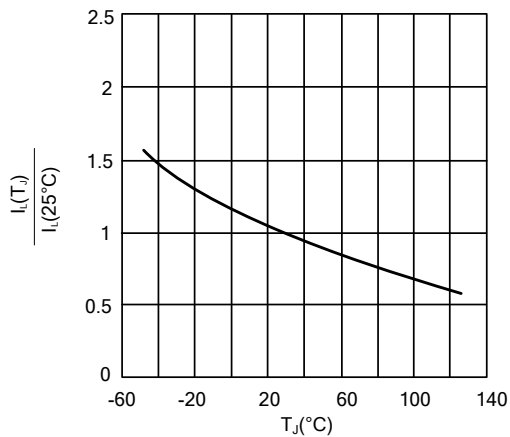

Normalized Holding Current as a Function of Junction Temperature; Typical Values.

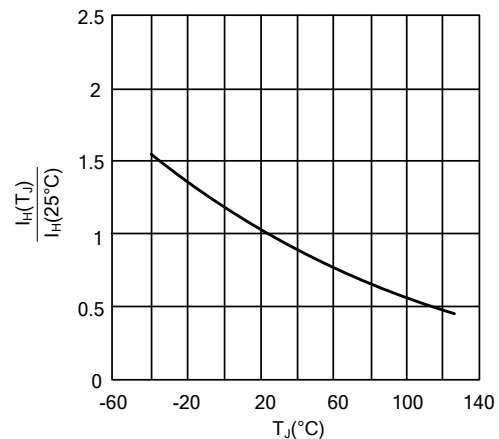

On-State Current as a Function of On-State Voltage; Typical and Maximum Values.

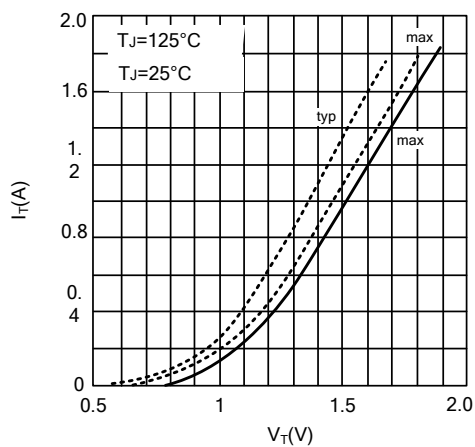

Critical Rate of Rise of Off-State Voltage as a Function of Junction Temperature; Typical Values.

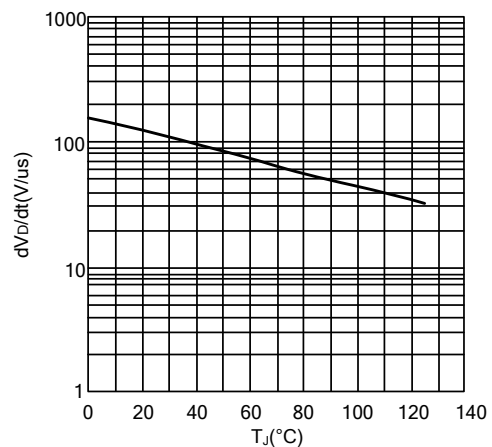

UTC assumes no responsibility for equipment failures that result from using products at values that exceed, even momentarily, rated values (such as maximum ratings, operating condition ranges, or other parameters) listed in products specifications of any and all UTC products described or contained herein. UTC products are not designed for use in life support appliances, devices or systems where malfunction of these products can be reasonably expected to result in personal injury. Reproduction in whole or in part is prohibited without the prior written consent of the copyright owner. The information presented in this document does not form part of any quotation or contract, is believed to be accurate and reliable and may be changed without notice.