

Passo 1:

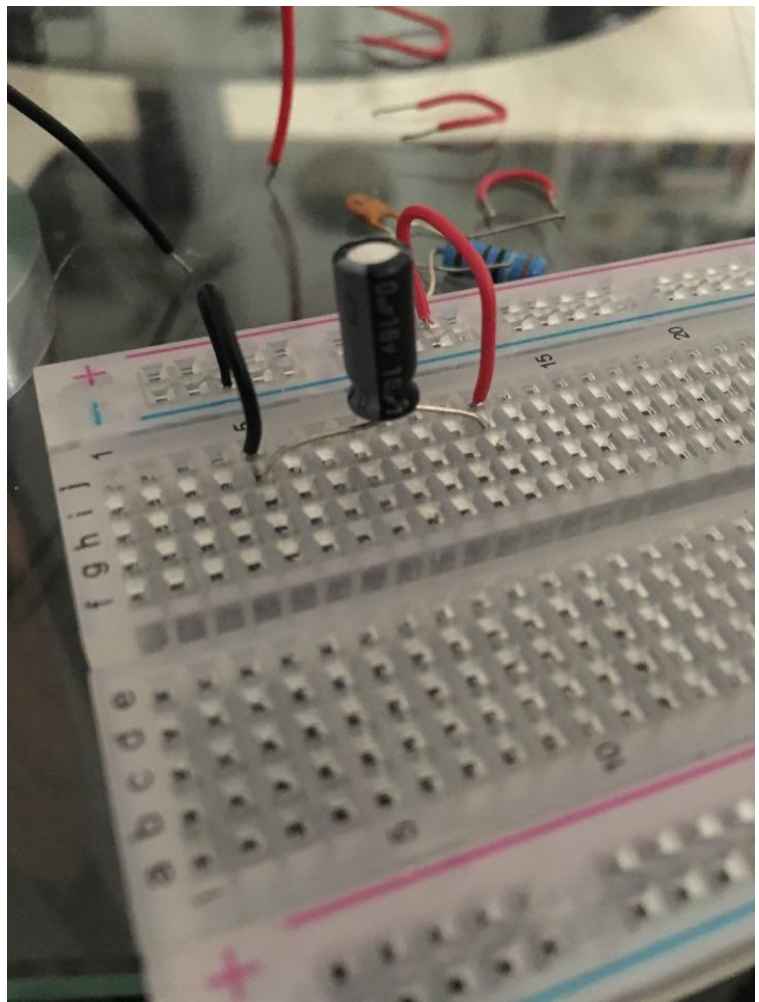

Passo 2:

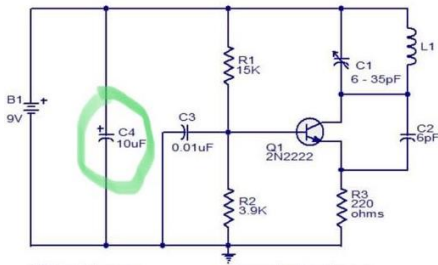
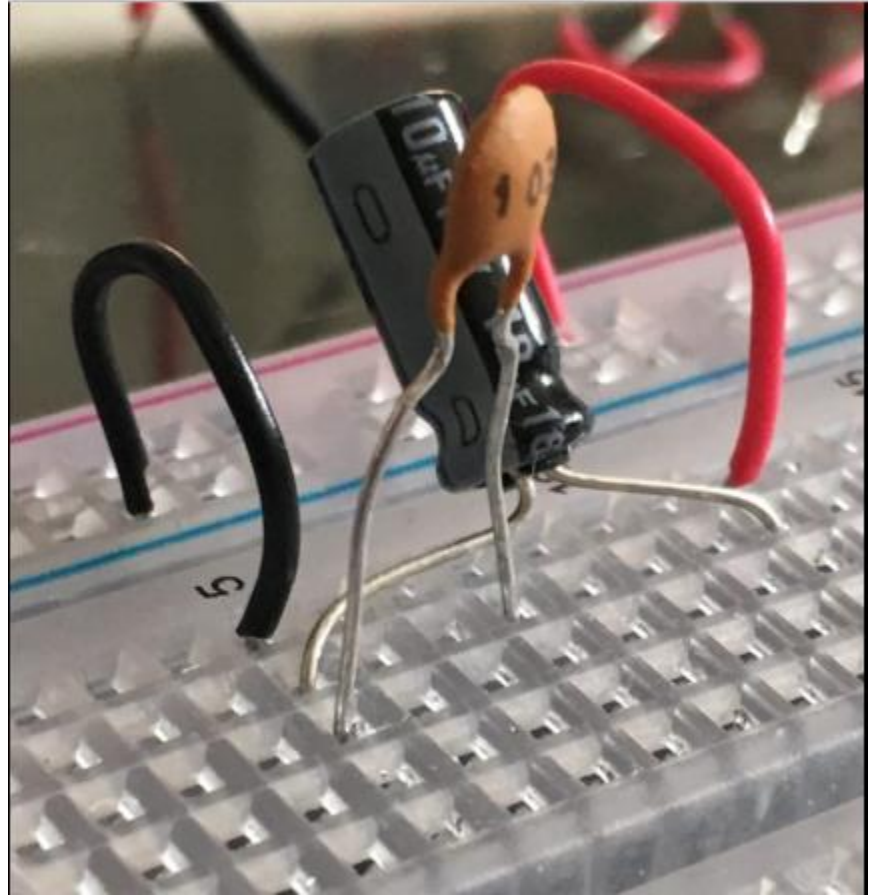
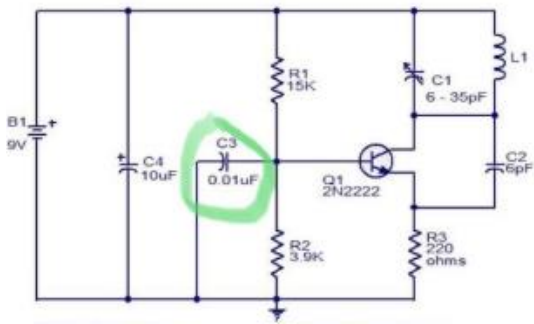

Passo 3:

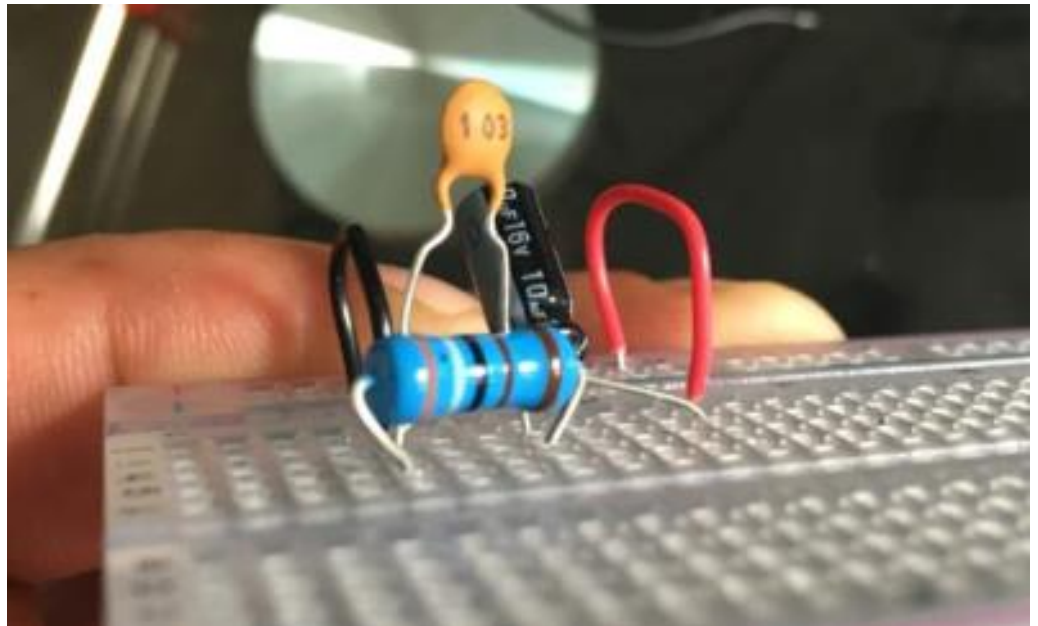
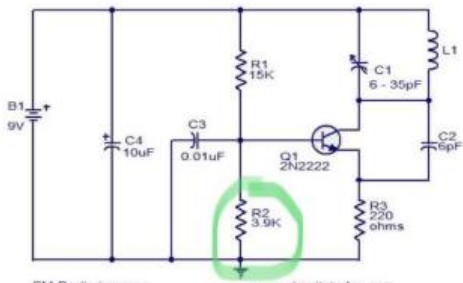

Passo 4:

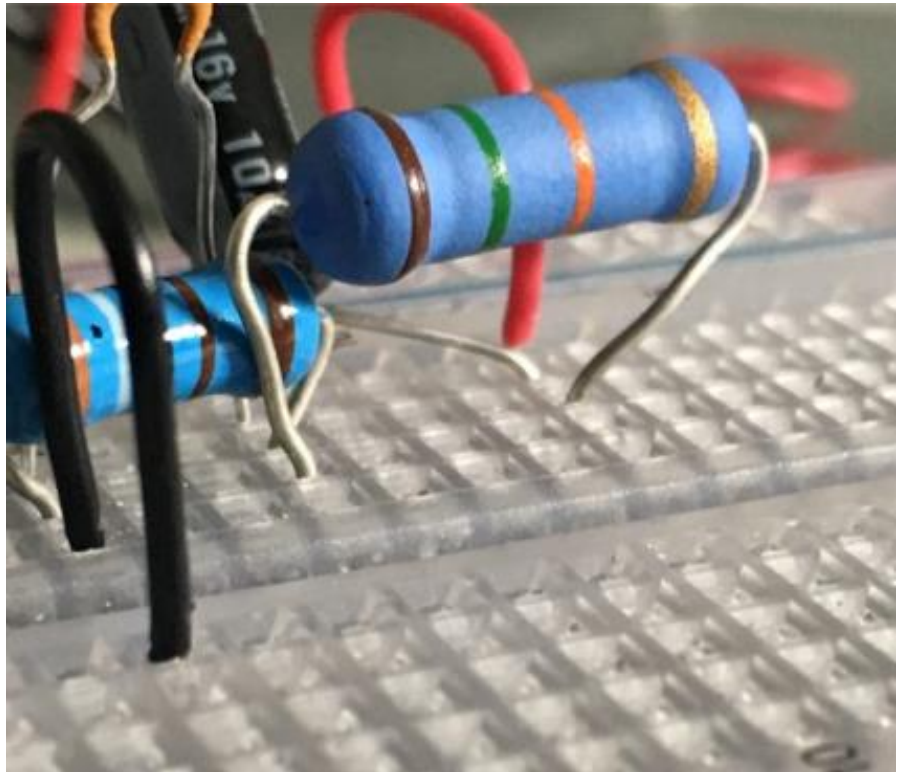
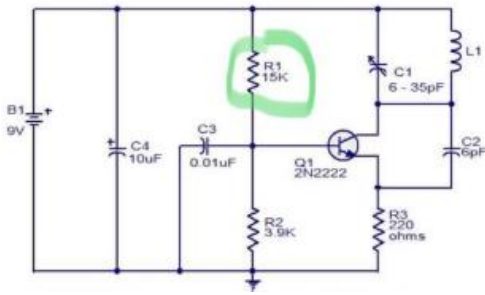

Ligação ao outro lado da placa:

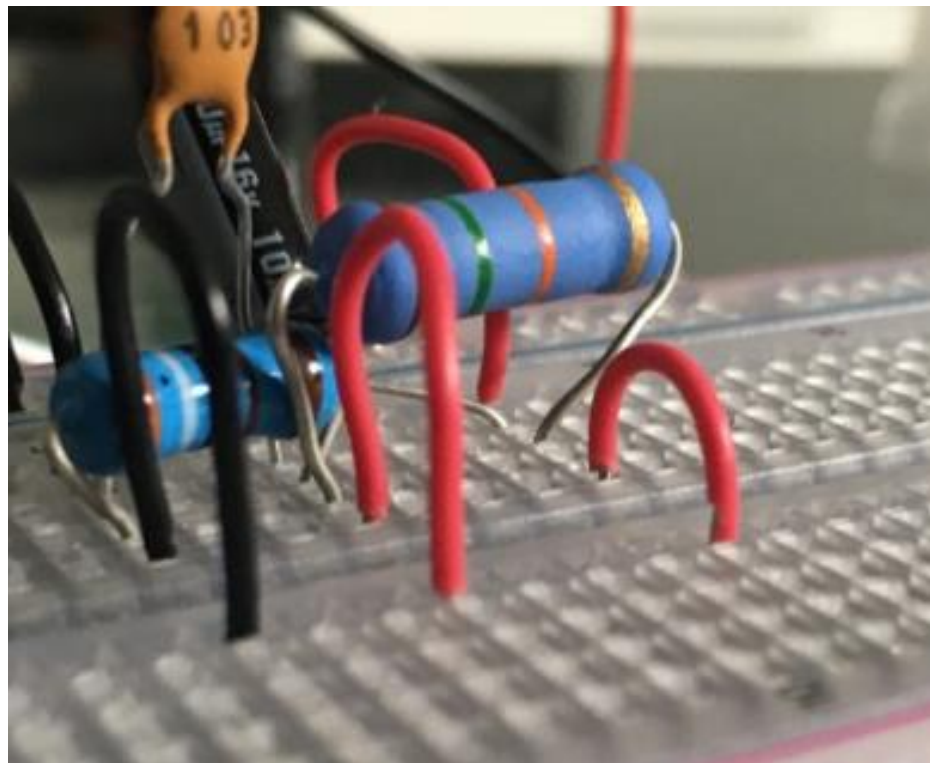

Passo 5:

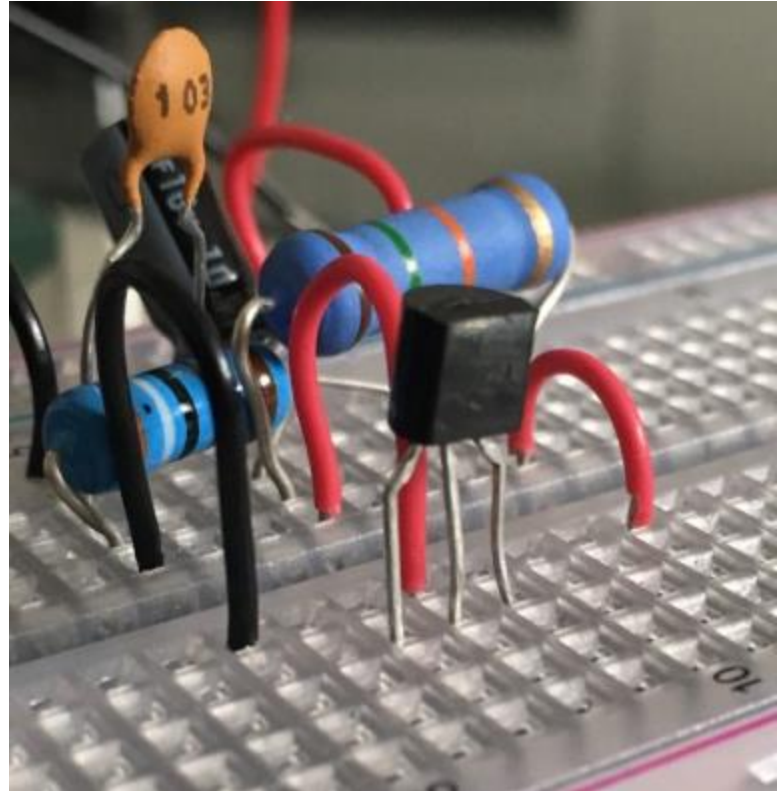
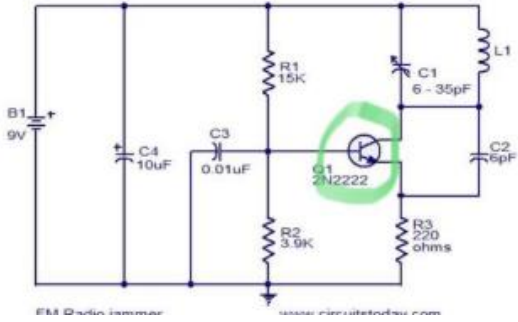

Transistor NPN a Base está no meio

Passo 6:

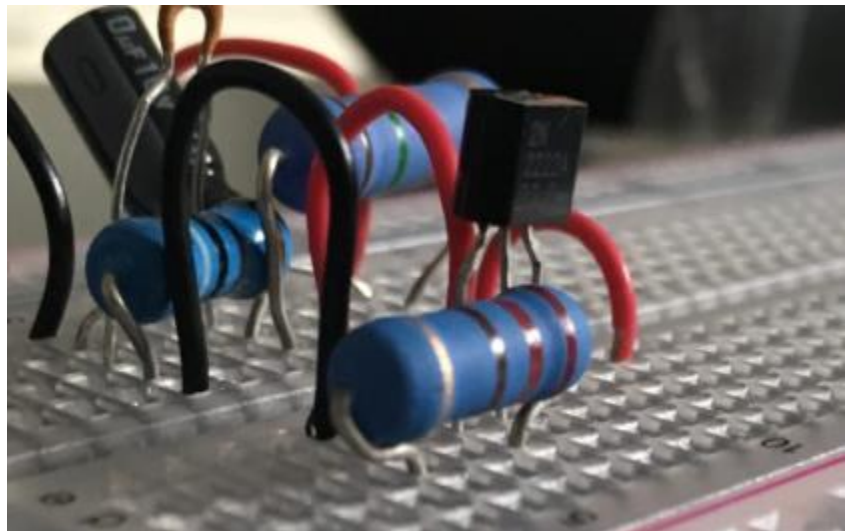
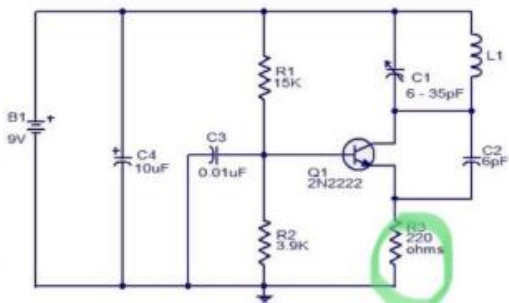

Passo 7:

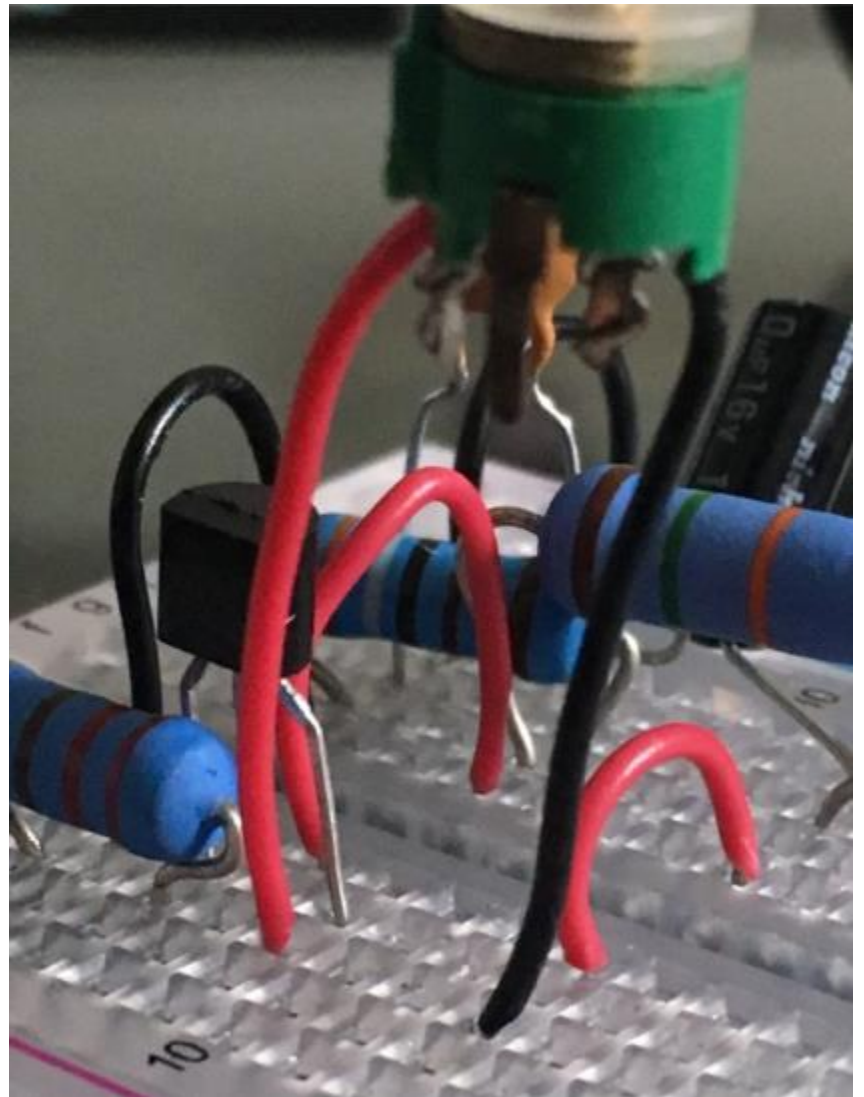
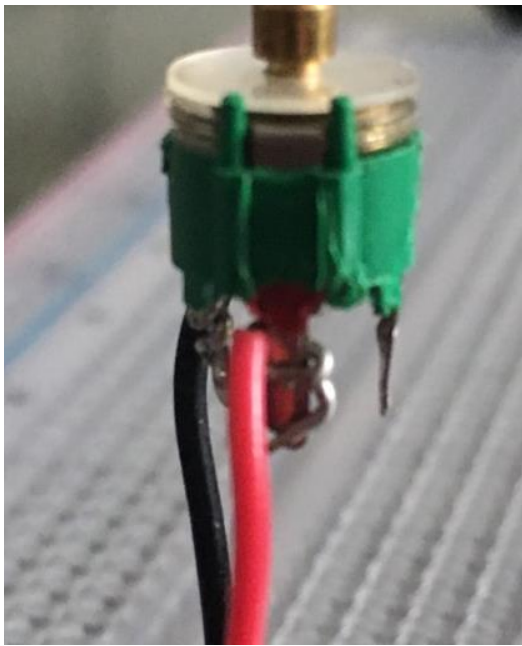
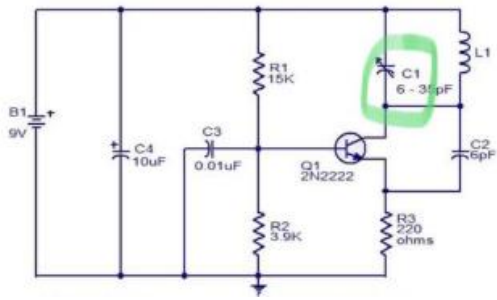

Passo 8:

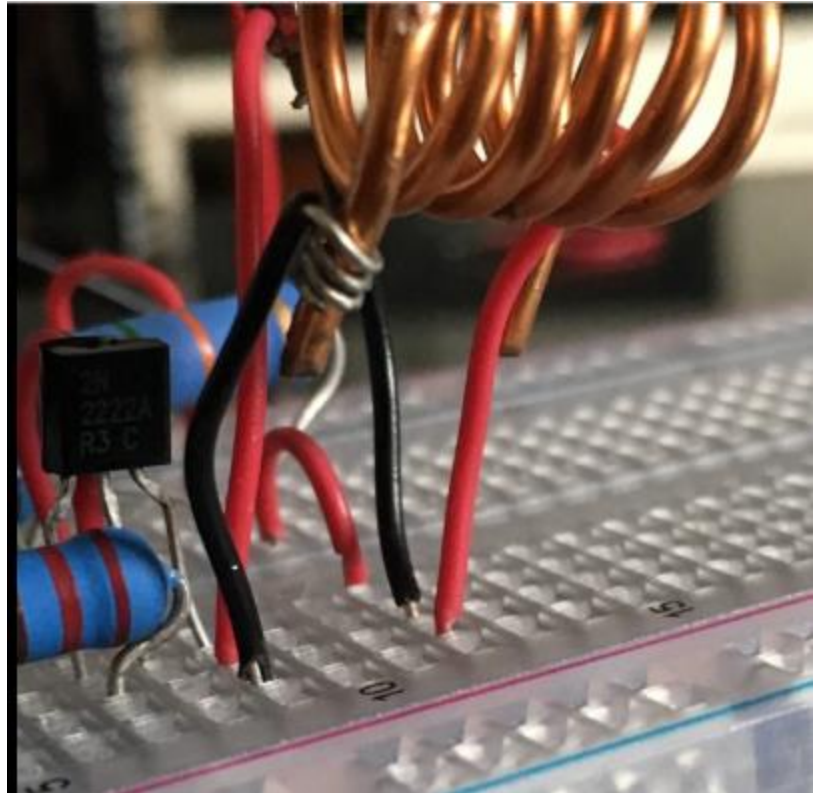
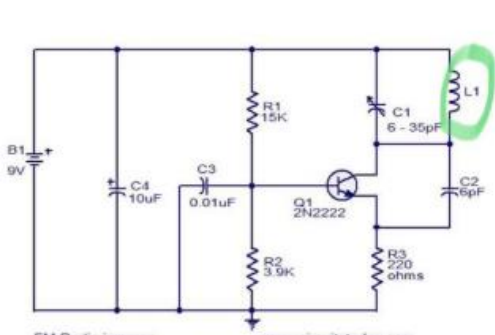

Fio cobre 1.6 mm, 6 voltas

Passo 9:

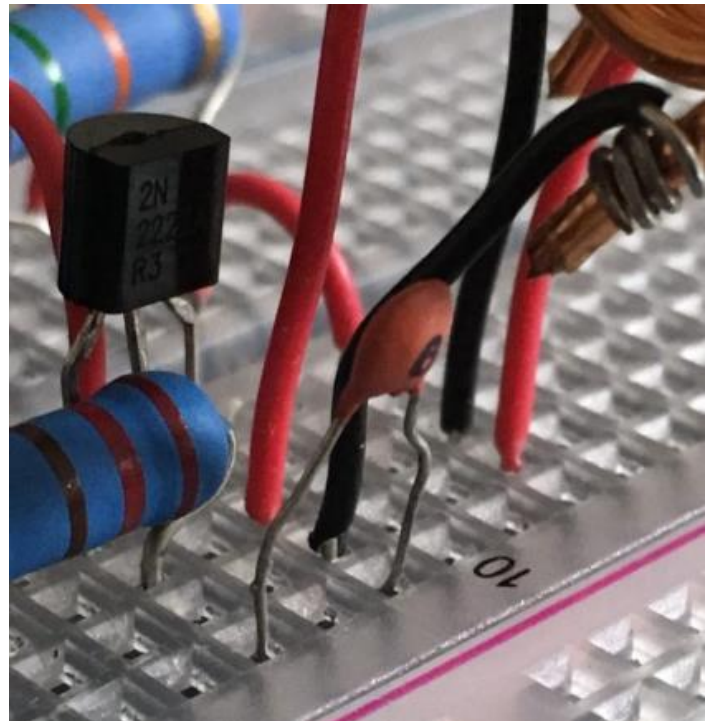
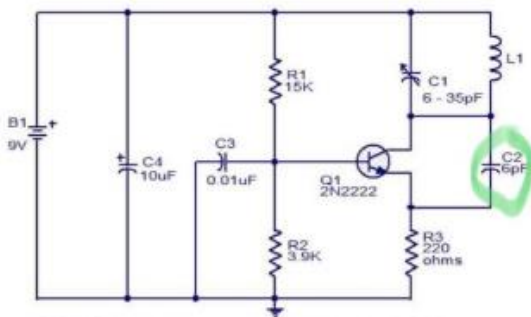

Passo 10 e final:

